

MAL209628222E3

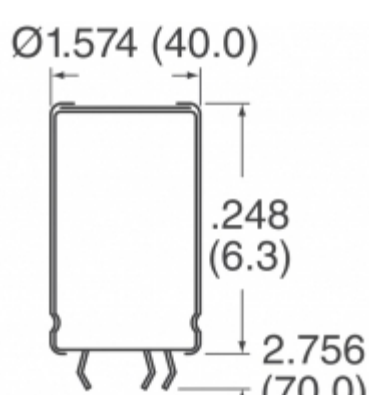

Obrázky jsou pouze orientační.
Podrobné informace o produktu naleznete v části Technické údaje produktu.
Koupit MAL209628222E3 s důvěrou od Component-World.HK, 1 rok záruka



Part Number: MAL209628222E3
Výrobce: Electro-Films (EFI) / Vishay
Popis: CAP ALUM 2200UF 20% 385V SNAP
Datový list: [096 PLL-4TSI \(MAL2096\) Series](#)
[Aluminum Electrolytic Capacitors Guide](#)

RoHs Status: Bez olova / V souladu RoHS
Ship From: Hong Kong
Shipment Way: DHL/Fedex/TNT/UPS/EMS







[Request For Quotation](#)

PARAMETR PRODUKTU

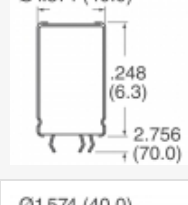
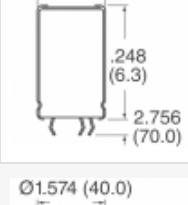
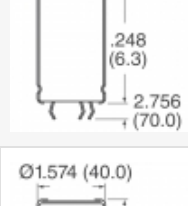
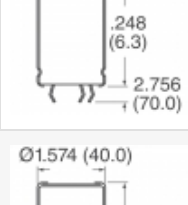
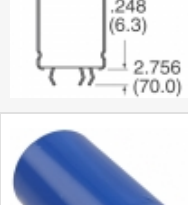
| | | | |
|---|--------------------------------|---|--|
| Part Number | MAL209628222E3 | Výrobce | Electro-Films (EFI) / Vishay |
| Popis | CAP ALUM 2200UF 20% 385V SNAP | Stav volného vedení / RoHS | Bez olova / V souladu RoHS |
| Dostupné množství | 2487 pcs | Datový list | 096 PLL-4TSI (MAL2096) Series Aluminum Electrolytic Capacitors Guide |
| Kategorie | Kondenzátory | Napětí - Jmenovitá | 385V |
| Tolerance | ±20% | Povrchová montáž Land Velikost | - |
| Velikost / Rozměry | 1.575" Dia (40.00mm) | Série | 096 PLL-4TSI |
| Ripple Current @ Low Frequency | 8.2A @ 100Hz | hodnocení | - |
| Polarizace | Polar | Obal | Tape & Box (TB) |
| Paket / krabice | Radial, Can - Snap-In - 4 Lead | Provozní teplota | -40°C ~ 85°C |
| Typ montáže | Through Hole | Úroveň citlivosti na vlhkost (MSL) | 1 (Unlimited) |
| Výrobní standardní doba výroby | 21 Weeks | Životnost @ Temp. | 5000 Hrs @ 85°C |
| Rozestup vývodů | 0.886" (22.50mm) | Stav volného vedení / RoHS | Lead free / RoHS Compliant |
| Impedance | 32 mOhms | Výška - Sedící (Max) | 3.937" (100.00mm) |
| ESR (Equivalent Resistance Series) | 173 mOhm @ 100Hz | Detailní popis | 2200µF 385V Aluminum Electrolytic Capacitors Radial, Can - Snap-In - 4 Lead 173 mOhm @ 100Hz 5000 Hrs @ 85°C |
| kapacitní | 2200µF | Aplikace | General Purpose |

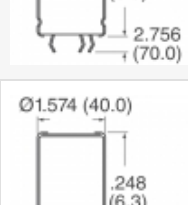
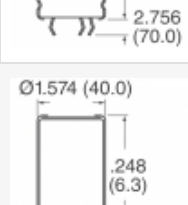
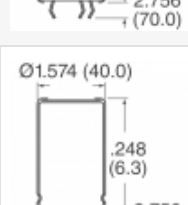
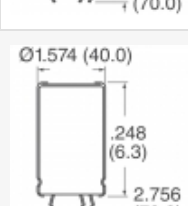
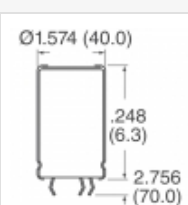
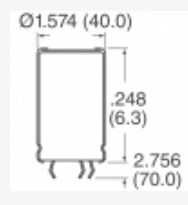
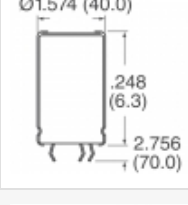
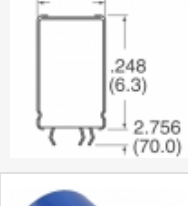
Component-World.com je spolehlivý distributor elektronických součástek. Specializujeme se na všechny elektronické komponenty řady Electro-Films (EFI) / Vishay. Máme 2487 kusy Electro-Films (EFI) / Vishay MAL209628222E3 na skladě dostupných. Vyžádejte si citát z distributora součástí elektroniky na Component-World.com, náš prodejní tým vás bude kontaktovat do 24 hodin.
RFQ Email: info@Components-World.com

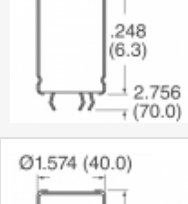
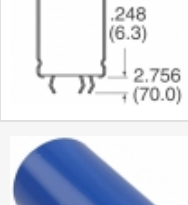
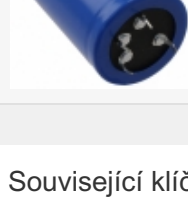
SOUVISEJÍCÍ PRODUKTY

| | | | |
|--|---|--|-----------------------|
|  | Část#: MAL209629561E3 Popis: CAP ALUM 560UF 20% 500V SNAP | Výrobci: Electro-Films (EFI) / Vishay | Dotaz |
|  | Část#: MAL209634222E3 Popis: CAP ALUM 2200UF 20% 420V SNAP | Výrobci: Electro-Films (EFI) / Vishay | Dotaz |
|  | Část#: MAL209626821E3 Popis: CAP ALUM 820UF 20% 400V SNAP | Výrobci: Electro-Films (EFI) / Vishay | Dotaz |
|  | Část#: MAL209628122E3 Popis: CAP ALUM 1200UF 20% 385V SNAP | Výrobci: Electro-Films (EFI) / Vishay | Dotaz |
|  | Část#: MAL209628681E3 Popis: CAP ALUM 680UF 20% 385V SNAP | Výrobci: Electro-Films (EFI) / Vishay | Dotaz |
|  | Část#: MAL209627122E3 Popis: CAP ALUM 1200UF 20% 450V SNAP | Výrobci: Electro-Films (EFI) / Vishay | Dotaz |
|  | Část#: MAL209629681E3 Popis: CAP ALUM 680UF 20% 500V SNAP | Výrobci: Electro-Films (EFI) / Vishay | Dotaz |
|  | Část#: MAL209627681E3 Popis: CAP ALUM 680UF 20% 450V SNAP | Výrobci: Electro-Films (EFI) / Vishay | Dotaz |
|  | Část#: MAL209634182E3 Popis: CAP ALUM 1800UF 20% 420V SNAP | Výrobci: Electro-Films (EFI) / Vishay | Dotaz |
|  | Část#: MAL209627102E3 Popis: CAP ALUM 1000UF 20% 450V SNAP | Výrobci: Electro-Films (EFI) / Vishay | Dotaz |
|  | Část#: MAL209634152E3 Popis: CAP ALUM 1500UF 20% 420V SNAP | Výrobci: Electro-Films (EFI) / Vishay | Dotaz |
|  | Část#: MAL209628102E3 Popis: CAP ALUM 1000UF 20% 385V SNAP | Výrobci: Electro-Films (EFI) / Vishay | Dotaz |
|  | Část#: MAL209628182E3 Popis: CAP ALUM 1800UF 20% 385V SNAP | Výrobci: Electro-Films (EFI) / Vishay | Dotaz |
|  | Část#: MAL209627152E3 Popis: CAP ALUM 1500UF 20% 450V SNAP | Výrobci: Electro-Films (EFI) / Vishay | Dotaz |
|  | Část#: MAL209628821E3 Popis: CAP ALUM 820UF 20% 385V SNAP | Výrobci: Electro-Films (EFI) / Vishay | Dotaz |
|  | Část#: MAL209628152E3 Popis: CAP ALUM 1500UF 20% 385V SNAP | Výrobci: Electro-Films (EFI) / Vishay | Dotaz |
|  | Část#: MAL209629821E3 Popis: CAP ALUM 820UF 20% 500V SNAP | Výrobci: Electro-Films (EFI) / Vishay | Dotaz |
|  | Část#: MAL209635152E3 Popis: CAP ALUM 1500UF 20% 350V SNAP | Výrobci: Electro-Films (EFI) / Vishay | Dotaz |
|  | Část#: MAL209627821E3 Popis: CAP ALUM 820UF 20% 450V SNAP | Výrobci: Electro-Films (EFI) / Vishay | Dotaz |
|  | Část#: MAL209629102E3 Popis: CAP ALUM 1000UF 20% 500V SNAP | Výrobci: Electro-Films (EFI) / Vishay | Dotaz |

Související klíčová slova pro MAL209628222E3

| | | | |
|--|--|--------------------------------------|--|
| Electro-Films (EFI) / Vishay MAL209628222E3. | MAL209628222E3 distributor | MAL209628222E3 dodavatel | MAL209628222E3 Cena |
| MAL209628222E3 Stáhnout datasheet. | MAL209628222E3 Datasheet. | MAL209628222E3 Stock. | koupit MAL209628222E3. |
| Electro-Films (EFI) / Vishay MAL209628222E3. | Electro-Films (EFI) / Vishay MAL209628222E3. | Vishay Electro-Films MAL209628222E3. | Phoenix Passive Components / Vishay MAL209628222E3. |